



Fő jellemzők

Termékcsalád	Harmony XB5
Termék vagy komponens típusa	Világító választókapcsoló fedél
Termékkompatibilitás	Beépített LED
Készülék rövid megnevezése	ZB5
Perem anyaga	Műanyag
Szerelési átmérő	22 mm
Fej típusa	Szabványos
Eladás oszthatatlan mennyiségenként	1
Jelzőegység fej	Kerek
Kezelő típusa	Rögzítő
Kezelőprofil	Zöld szabványos fogantyú
Kezelő helyzet információ	3 állás, +/- 45°

Kiegészítők

CAD teljes szélesség	29 mm
CAD teljes magasság	29 mm
CAD teljes mélység	43 mm
Termék súlya	0.016 kg
Mechanikus tartósság	1000000 ciklus
Állomás neve	XALD 1...5 kivágás XALK 2...5 kivágás
Elektromos felpítés kódja	M6 for 2 contacts using single blocks in front mounting with integral LED and transformer M10 for 2 contacts using single blocks in front mounting with integral LED M3 for 4 contacts using single blocks in front mounting with integral LED M4 for 4 contacts using single and double blocks in front mounting with integral LED MF1 for 2 contacts using single blocks in front mounting with integral LED MR1 for 2 contacts using single blocks in rear mounting with integral LED

Környezet

védőkezelés	TH
környezeti levegő hőmérséklet tárolásra	-40...70 °C
üzemi környezeti levegő hőmérséklet	-40...70 °C
Tűlfeszültségi kategória	II. osztály megfelel IEC 60536
IP védettség szint	IP67 IP66 megfelel IEC 60529 IP69K IP69
NEMA védettség szint	NEMA 13 NEMA 4X
ellenállás nagy nyomású mosóval szemben	7000000 Pa -55 °C, távolság: 0,1 m
IK védelmi fokozat	IK06 megfelel IEC 50102
szabványok	EN/IEC 60947-1 EN/IEC 60947-5-1 EN/IEC 60947-5-4 EN/IEC 60947-5-5 JIS C 4520 UL 508 CSA C22.2 No 14
termékbizonyítványok	BV CSA DNV GL

A dokumentumban található információk a termékek teljesítményével kapcsolatos általános leírásokat és/vagy műszaki jellemzőket tartalmaznak. A dokumentum nem használható a termékek egyedi felhasználói alkalmazások tekintetében való alkalmazásának és megbízhatóságának meghatározására. Az adott körülmények közötti alkalmazás tekintetében a megfelelő kockázatelemzések elvégzése, valamint a termékek értékelése és tesztelése a felhasználó vagy a szerelést végző szakember feladata. Sem a Schneider Electric Industries SAS, sem annak leányvállalatai vagy kapcsoló vállalkozásai nem vállalnak felelősséget a dokumentumban foglaltaktól eltérő használatból eredő következményekért.

rezgési ellenállás	5 gn (f = 2...500 Hz) megfelel IEC 60068-2-6
ütésállóság	30 gn (időtartam = 18 ms) esetén fél szinuszos hullám gyorsulás megfelel IEC 60068-2-27 50 gn (időtartam = 11 ms) esetén fél szinuszos hullám gyorsulás megfelel IEC 60068-2-27

Dimensions

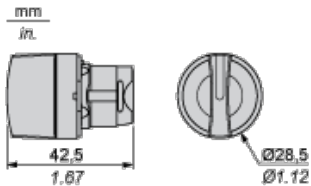

Panel Cut-out for Pushbuttons, Switches and Pilot Lights (Finished Holes, Ready for Installation)

Connection by Screw Clamp Terminals or Plug-in Connectors or on Printed Circuit Board

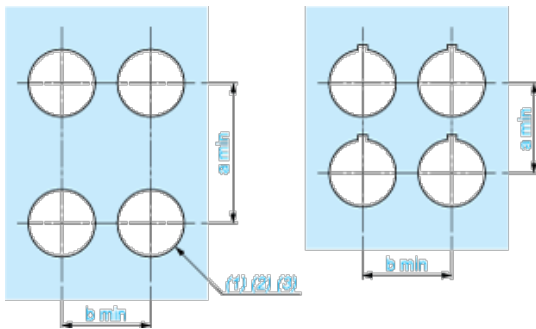

- (1) Diameter on finished panel or support
- (2) For selector switches and Emergency stop buttons, use of an anti-rotation plate type ZB5AZ902 is recommended.
- (3) Ø22.5 mm recommended ($\text{Ø}22.3_{0}^{+0.4}$) / Ø0.89 in. recommended ($\text{Ø}0.89_{0}^{+0.016}$)

Connections	a in mm	a in in.	b in mm	b in in.
By screw clamp terminals or plug-in connector	40	1.57	30	1.18
By Faston connectors	45	1.77	32	1.26
On printed circuit board	30	1.18	30	1.18

Detail of Lug Recess

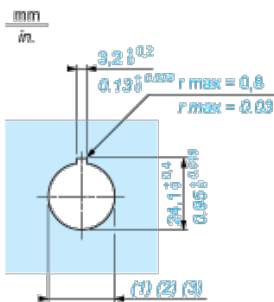

- (1) Diameter on finished panel or support
- (2) For selector switches and Emergency stop buttons, use of an anti-rotation plate type ZB5AZ902 is recommended.
- (3) Ø22.5 mm recommended ($\text{Ø}22.3_{0}^{+0.4}$) / Ø0.89 in. recommended ($\text{Ø}0.89_{0}^{+0.016}$)

Pushbuttons, Switches and Pilot Lights for Printed Circuit Board Connection

Panel Cut-outs (Viewed from Installer's Side)

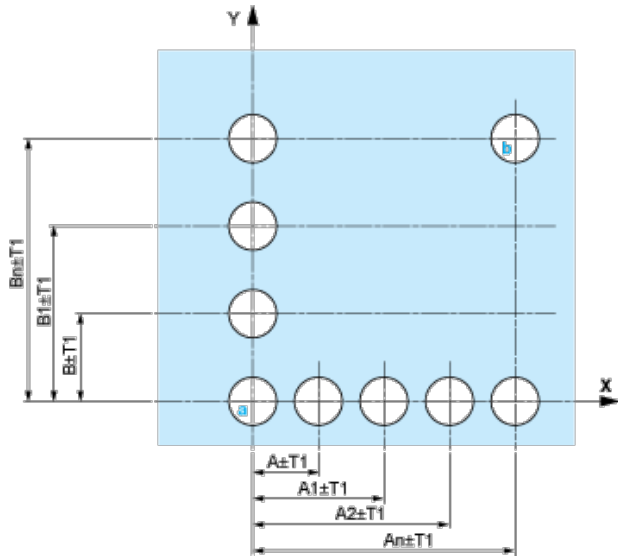

A: 30 mm min. / 1.18 in. min.

B: 40 mm min. / 1.57 in. min.

Printed Circuit Board Cut-outs (Viewed from Electrical Block Side)

Dimensions in mm

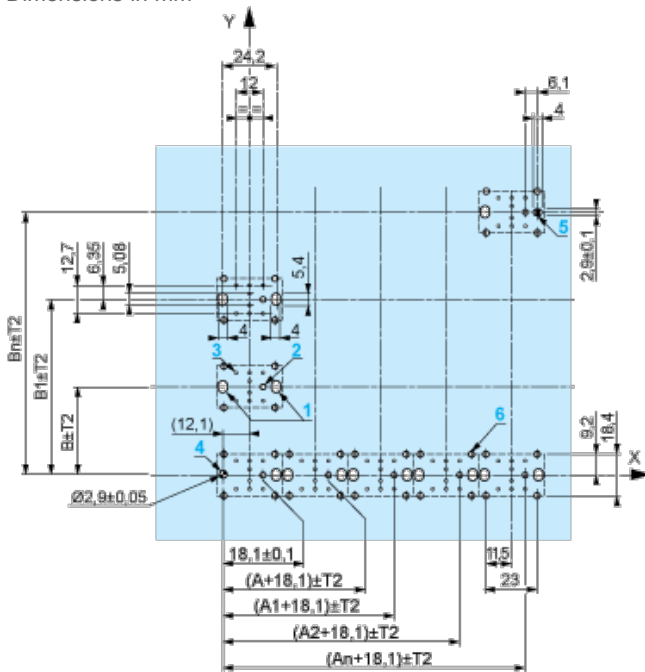

A: 30 mm min.

B: 40 mm min.

Dimensions in in.



A: 1.18 in. min.

B: 1.57 in. min.

General Tolerances of the Panel and Printed Circuit Board

The cumulative tolerance must not exceed 0.3 mm / 0.012 in.: $T1 + T2 = 0.3 \text{ mm max.}$

Installation Precautions

- | Minimum thickness of circuit board: 1.6 mm / 0.06 in.
- | Cut-out diameter: 22.4 mm \pm 0.1 / 0.88 in. \pm 0.004
- | Orientation of body/fixing collar ZB5AZ009: \pm 2°30' (excluding cut-outs marked **a** and **b**).
- | Tightening torque of screws ZBZ006: 0.6 N.m (5.3 lbf.in) max.
- | Allow for one ZB5AZ079 fixing collar/pillar and its fixing screws:
 - | every 90 mm / 3.54 in. horizontally (X), and 120 mm / 4.72 in. vertically (Y).
 - | with each selector switch head (ZB5AD•, ZB5AJ•, ZB5AG•).

The fixing centers marked **a** and **b** are diagonally opposed and must align with those marked **4** and **5**.



- (1) Head ZB5AD•
- (2) Panel
- (3) Nut
- (4) Printed circuit board

Mounting of Adapter (Socket) ZBZ01•

- | 1 2 elongated holes for ZBZ006 screw access
- | 2 1 hole \varnothing 2.4 mm \pm 0.05 / 0.09 in. \pm 0.002 for centring adapter ZBZ01•
- | 3 8 \times \varnothing 1.2 mm / 0.05 in. holes
- | 4 1 hole \varnothing 2.9 mm \pm 0.05 / 0.11 in. \pm 0.002, for aligning the printed circuit board (with cut-out marked **a**)

- | 5 1 elongated hole for aligning the printed circuit board (with cut-out marked **b**)
- | 6 4 holes \varnothing 2.4 mm / 0.09 in. for clipping in adapter ZBZ01•

Dimensions An + 18.1 relate to the \varnothing 2.4 mm \pm 0.05 / 0.09 in. \pm 0.002 holes for centring adapter ZBZ01•.

Electrical Composition Corresponding to Code M3

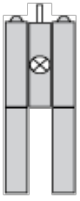

Electrical Composition Corresponding to Code M4



Electrical Composition Corresponding to Codes M6 and P2

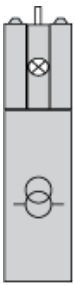

Electrical Composition Corresponding to Codes M5, M10, MF1, MR1 and MF2

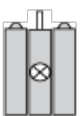

Legend

Single contact



Double contact



Light block



Possible location



Sequence of Contacts Fitted to 3-position Selector Switch Body

Position 315°



Push	Position	Top			
		Bottom			
	Location		Left		Right
	State		1		0
Contacts	N/O		closed	open	
	N/C		open	closed	

Position 0°



Push	Position	Top			
		Bottom			
	Location		Left		Right
	State		0		0
Contacts	N/O		open	open	
	N/C		closed	closed	

Position 45°



Push	Position	Top			
		Bottom			
	Location		Left		Right
	State		0		1
Contacts	N/O		open	closed	
	N/C		closed	open	